

# Dryer

## DE-170 Parts Manual

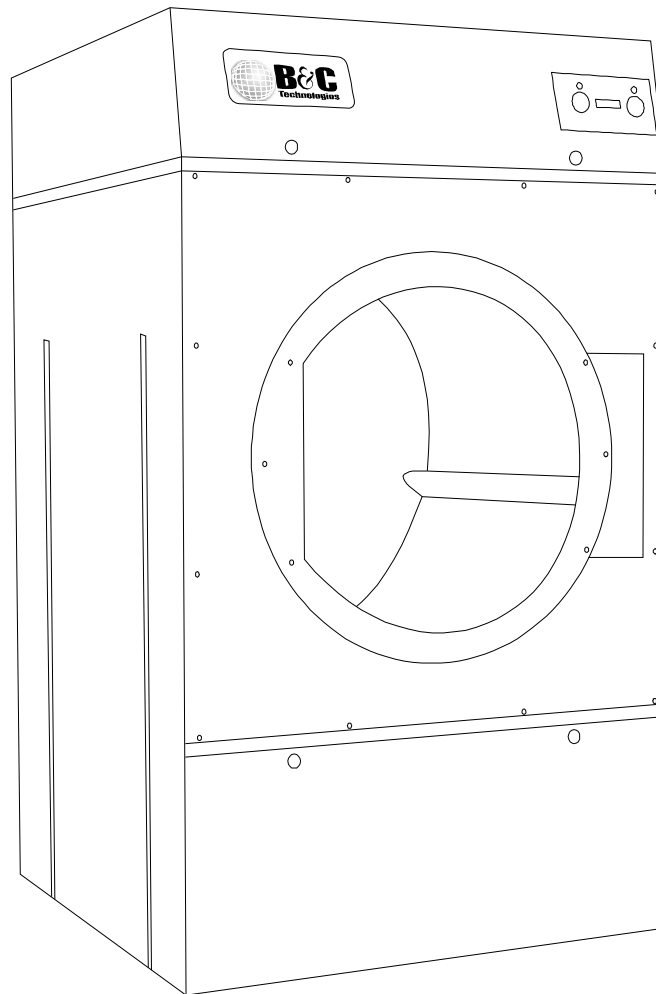

### B&C Technologies

Panama City, FL  
(850) 249-2222  
(850) 249-2226 FAX  
[www.bandctech.com](http://www.bandctech.com)

### Accurate Technologies

Samutprakarn, Thailand  
+66 (0) 2740-5511  
+66 (0) 2740-5522 FAX  
[www.accuratethai.com](http://www.accuratethai.com)





Item	Part No.	Qty.	Description
1	A2-S170-001	1	Front panel assembly, top
2	A2-S170-002	1	Front panel assembly, middle
3	A2-S170-005	1	Door handle
4	A0-A090-008	1	Sticker logo
5	A2-S170-007	1	Door hinge
6	A2-S170-004	1	Door lint drawer filter
7	A2-S170-003	1	Front panel assembly, lower
8	A2-S170-010	1	Right panel assembly, top
9	A2-S170-011	1	Right panel assembly, lower
10	A2-S170-009	1	Left panel assembly, top
11	A2-S170-008	1	Left panel assembly, lower
12	A0-A013-002	2	Lock, Top panel
13	A0-A081-003	6	Cap nut
14	A0-A060-006	16	Screw
15	A2-SDE1-029	1	External mounting panel for EDG control
16	A2-SDE1-030	1	External mounting panel for Timer control

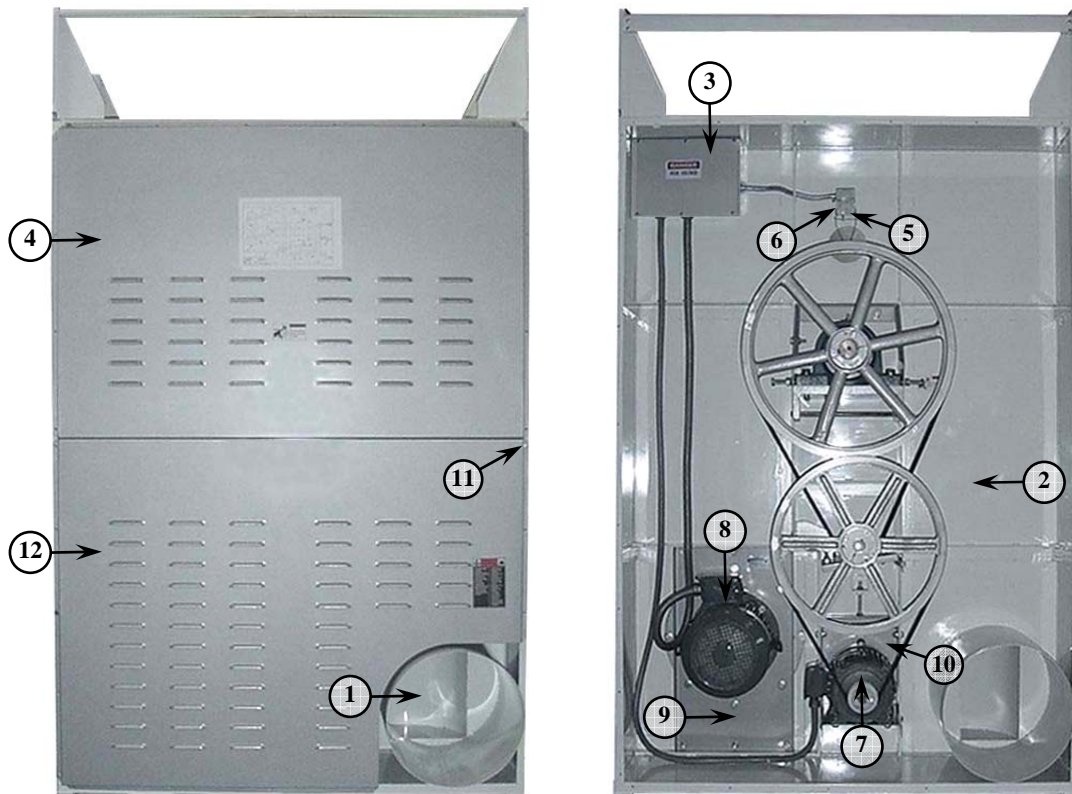

Item	Part No.	Qty.	Description
1	A2-S170-012	1	Exhaust duct outlet
2	A2-S170-023	1	Panel, Rear
3	A2-S170-022	1	Electrical box
4	A2-S170-013	1	Rear panel assembly, Upper
5	A0-E014-010	1	Micro switch
6	A2-S170-033	1	Micro switch box
7	A0-E008-818	1	Motor
	A0-E008-876	1	Motor "Hitachi"
8	A0-E008-817	1	Motor
	A0-E008-877	1	Motor "Hitachi"
9	A2-S170-031	1	Basket motor plate
10	A2-S170-032	1	Suction fan Motor plate
11	A0-A078-012	25	Hexagon bolt
12	A2-S170-014	1	Rear panel assembly, Lower

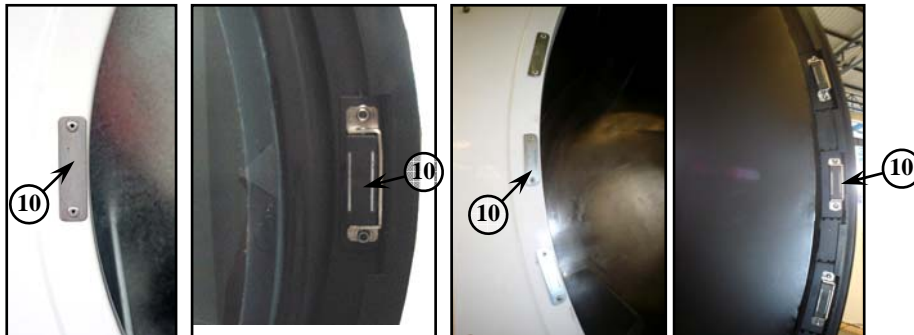
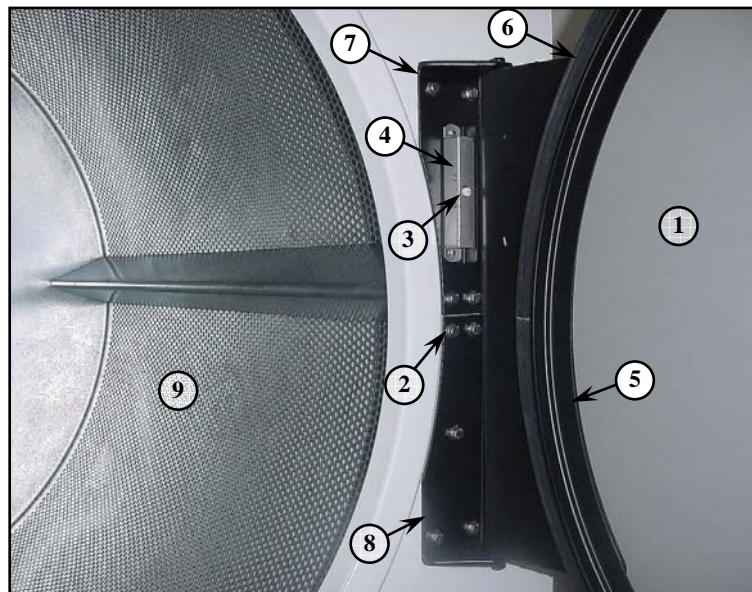

Item	Part No.	Qty.	Description
1	A0-A003-011	1	Door glass (Tempered)
2	A0-A078-012	9	Hexagon bolt, Stainless
3	A0-E015-017	1	Door switch
4	A2-S170-028	1	Door switch box
5	A2-S170-006	1	Door ring
6	A0-A001-048	1	Door gasket
7	A2-S170-029	1	Door hinge panel top
8	A2-S170-030	1	Door hinge panel lower
9	A2-S170-016	1	Basket galvanized sheet
	A2-S170-017	1	Basket stainless steel sheet
10	A0-A036-004	3	Magnet catch

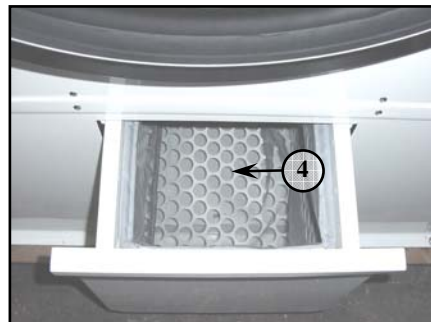
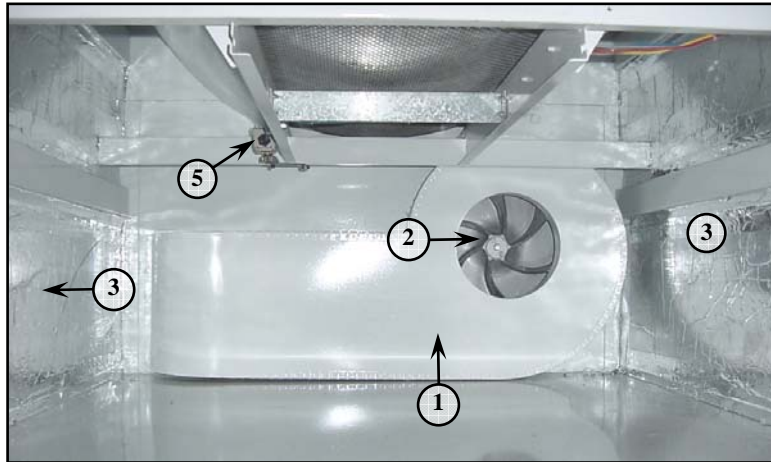

Item	Part No.	Qty.	Description
1	A2-S170-019	1	Fan side plate
2	A0-M003-006	1	Wheel suction fan
3	A0-A040-001	1	Micro fiber
4	A0-A043-006	1	Lint drawer filter
5	A0-E011-017	1	Limit Switch
6	A0-E015-011	1	Switch, limit momentary



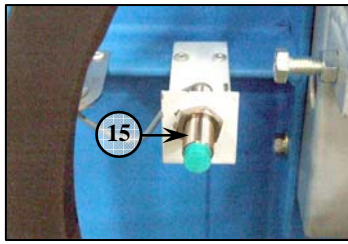

Option : Rotation Sensor

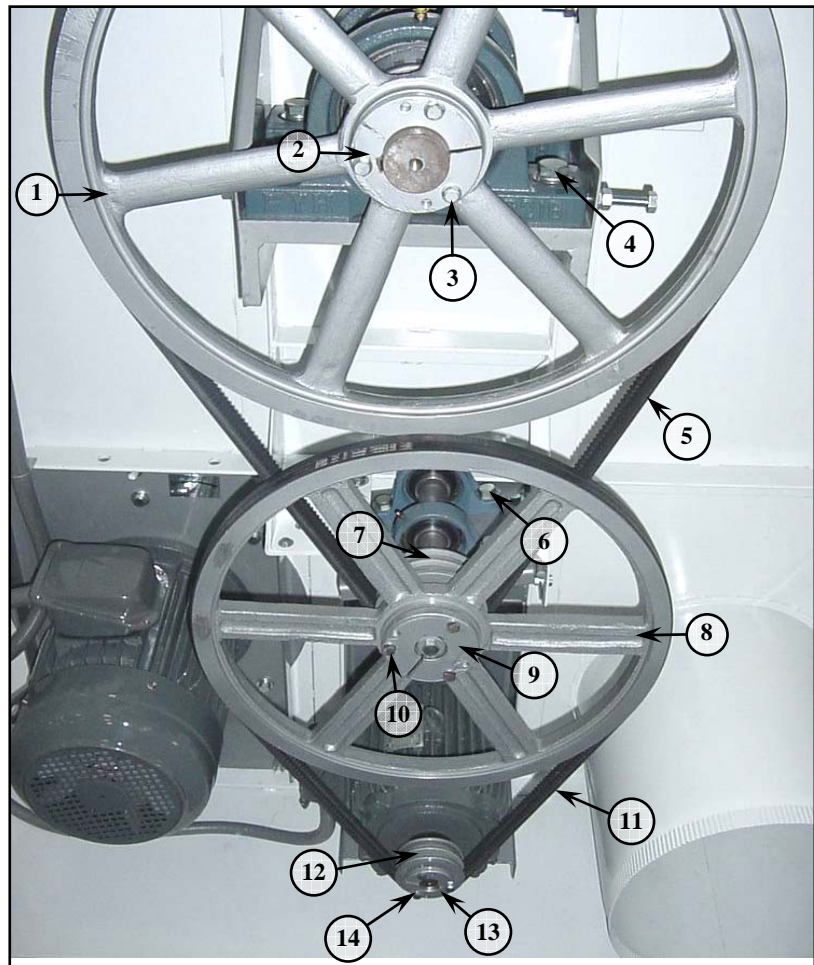

Item	Part No.	Qty.	Description
1	A0-M008-033	1	Basket pulley
2	A0-M009-038	1	Basket pulley bushing
3	A0-A079-027	3	Hexagon bolt
4	A0-A079-014	4	Hexagon bolt
5	A0-A002-009	2	V-Belt
6	A0-A079-024	4	Hexagon bolt
7	A0-M008-034	1	Drive sheave
	A0-M009-039	1	Drive sheave bushing
	A0-A079-029	3	Hexagon bolt
8	A0-M008-036	1	Idle pulley
9	A0-M009-041	1	Idle pulley bushing
10	A0-A079-028	3	Hexagon bolt
11	A0-A002-004	2	V-Belt
12	A0-M008-035	1	Motor sheave (For 60Hz.)
	A0-M008-095	1	Motor sheave (For 50Hz.)
13	A0-M009-040	1	Motor sheave bushing
14	A0-A079-029	3	Hexagon bolt
15	A0-E023-009	1	Rotation sensor (Proximity sensor)



Item	Part No.	Qty.	Description
1	A0-M011-007	1	Basket shaft
2	A0-M011-008	1	Idler shaft
3	A0-A079-023	2	Hexagon bolt
4	A0-A004-040	2	Bearing pillow block unit+Housing
	A0-A006-013	-	Adapters
5	A0-A079-024	2	Hexagon bolt
6	A0-A079-024	2	Hexagon bolt
7	A0-A004-039	2	Bearing pillow block
8	A0-A079-023	2	Hexagon bolt
9	A2-S170-024	1	Bearing mount, top
10	A2-S170-025	1	Bearing mount, lower



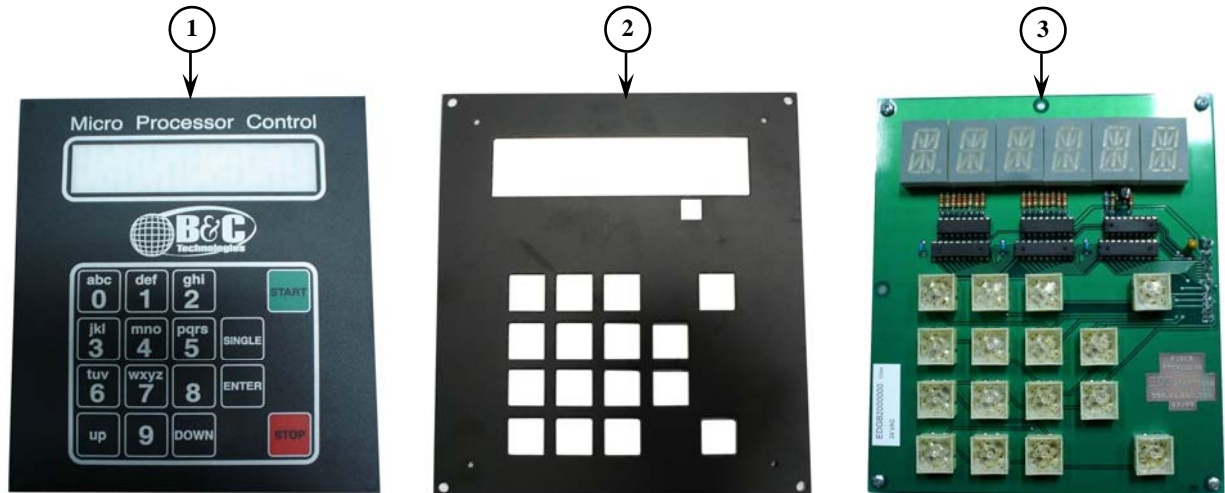

Model : Microprocessor control

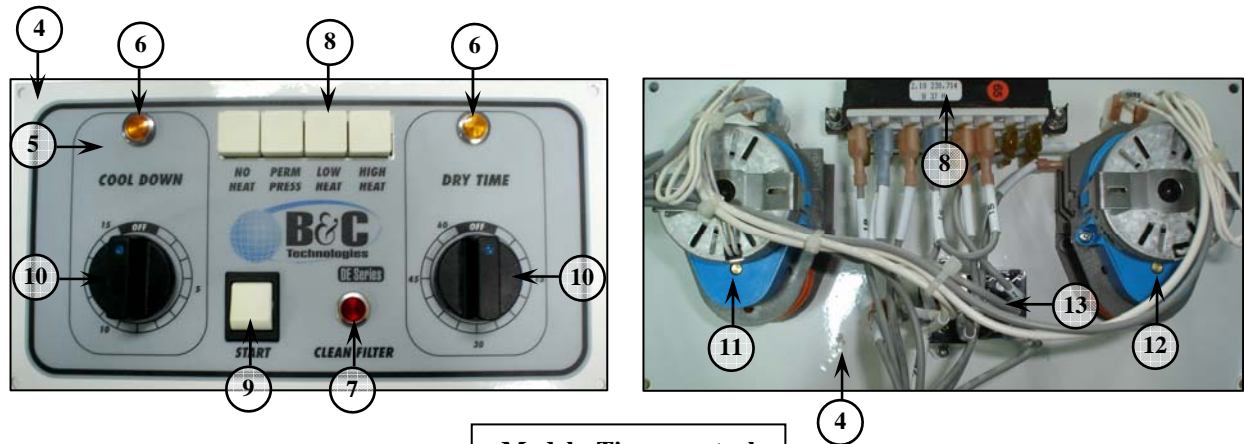

Model : Timer control

Item	Part No.	Qty.	Description
1	A0-A090-039	1	Decal for microprocessor controller (EDG)
2	A2-SDE1-024	1	Controller plate (For EDG)
3	A0-E007-004	1	Microprocessor controller (EDG)
4	A2-SDE1-025	1	Controller plate (For timer)
5	A0-A090-049	1	Decal for timer controller
6	A0-E059-006	2	Indicator lamp (Amber)
7	A0-E059-005	1	Indicator lamp (Red)
8	A0-E033-011	1	Selector switch (4 Push button)
9	A0-E033-009	1	Switch On-Off
10	A0-A086-004	2	Knob, Pointer control
11	A0-E031-002	1	Timer controller (60 min)
12	A0-E031-003	1	Timer controller (15 min)
13	A0-E009-017	1	Relay

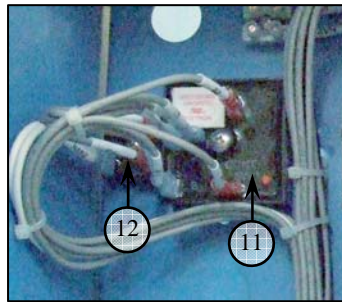
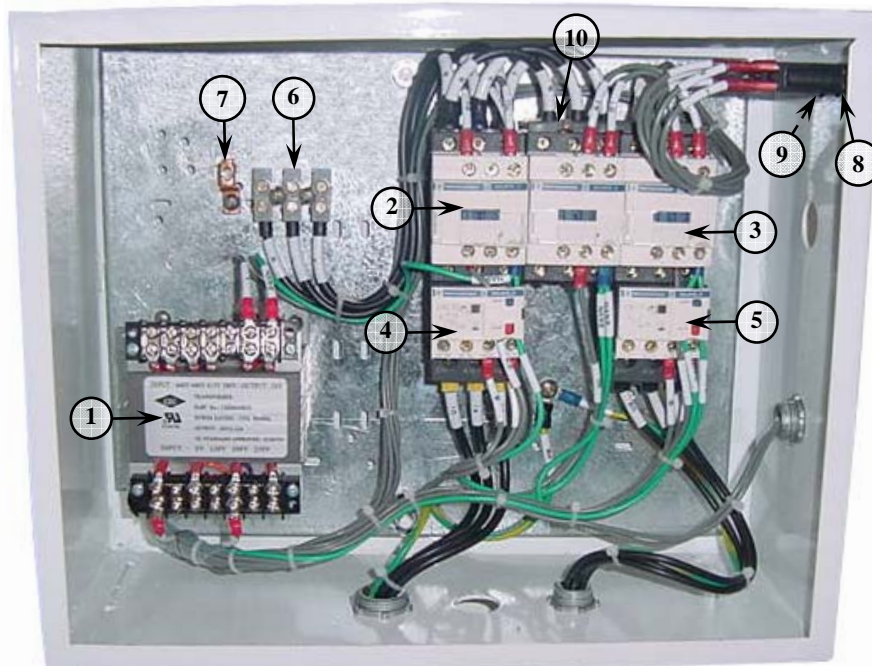

Option : Rotation Sensor

Item	Part No.	Qty.	Description
1	A0-E006-029	1	Transformer
2	A0-E004-036	1	Magnetic Contractor,
3	A0-E004-011	2	Magnetic Contractor,
4	A0-E025-025	1	Over load 220-240 V.
	A0-E025-021	1	Over load 380-460 V.
5	A0-E025-018	1	Over load 220-240 V.
	A0-E025-005	1	Over load 380-460 V.
6	A0-E021-031/1	1	Terminal, Block
7	A0-E055-001	1	Connector, Ground lug
8	A0-E010-031	2	Circuit breaker
9	A0-E010-034	1	Circuit breaker
10	A0-E036-002	1	Mechanical interlock
11	A0-E031-019	1	Watch dog timer
12	A0-E050-002	1	Bridge Rectifier

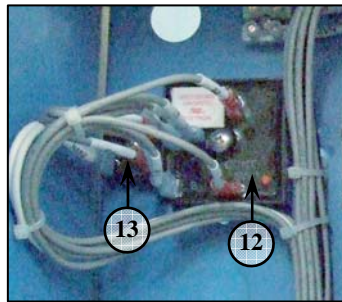
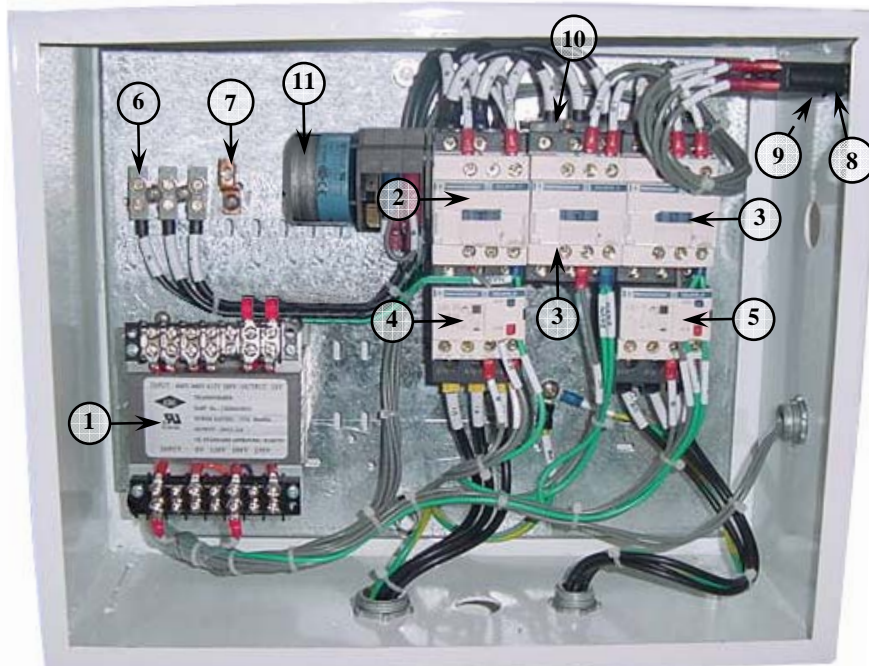

Option : Rotation Sensor

Item	Part No.	Qty.	Description
1	A0-E006-029	1	Transformer
2	A0-E004-036	1	Magnetic Contractor
3	A0-E004-011	2	Magnetic Contractor
4	A0-E025-025	1	Over load 220-240 V.
	A0-E025-021	1	Over load 380-460 V.
5	A0-E025-018	1	Over load 220-240 V.
	A0-E025-005	1	Over load 380-460 V.
6	A0-E021-031/1	1	Terminal, Block
7	A0-E055-001	1	Connector, Ground lug
8	A0-E010-031	2	Circuit breaker
9	A0-E010-034	1	Circuit breaker
10	A0-E036-002	1	Mechanical interlock
11	A0-E017-002	1	Reversing timer
12	A0-E031-019	1	Watch dog timer
13	A0-E050-002	1	Bridge Rectifier

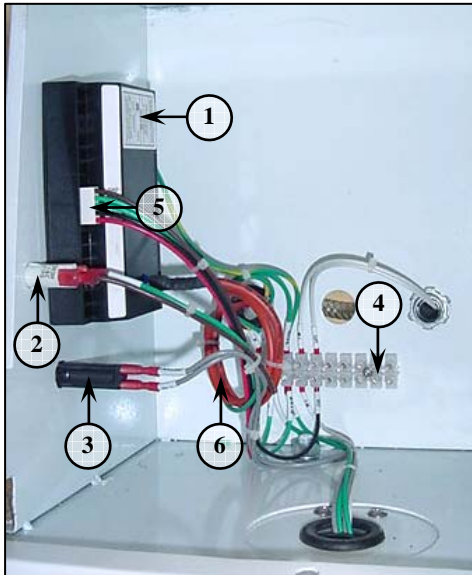

Model : Timer control

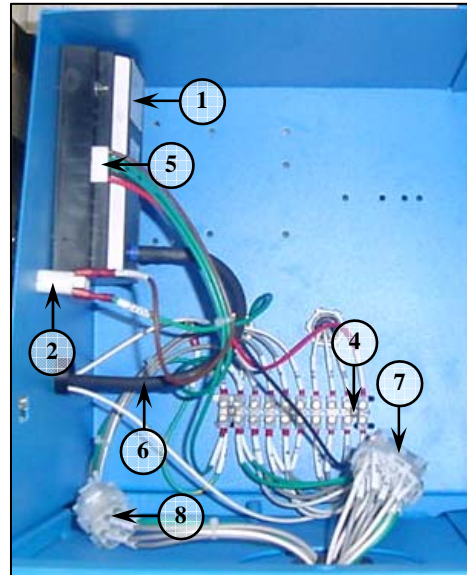

Model : Microprocessor control

Item	Part No.	Qty.	Description
1	A0-E020-001	1	Ignition control
2	A0-E059-005	1	Lamp, indicator
3	A0-E010-034	1	Circuit breaker
4	A0-E021-039	1	Block terminal
5	A0-E020-202	1	Wiring harnesses
6	A0-E019-006	1	Wire, Suppression
7	A0-E055-006	1	Connector housing male (15Pole)
	A0-E055-007	1	Connector housing female (15Pole)
8	A0-E055-005	1	Connector housing male (9Pole)
	A0-E055-004	1	Connector housing female (9Pole)





Model : Microprocessor control

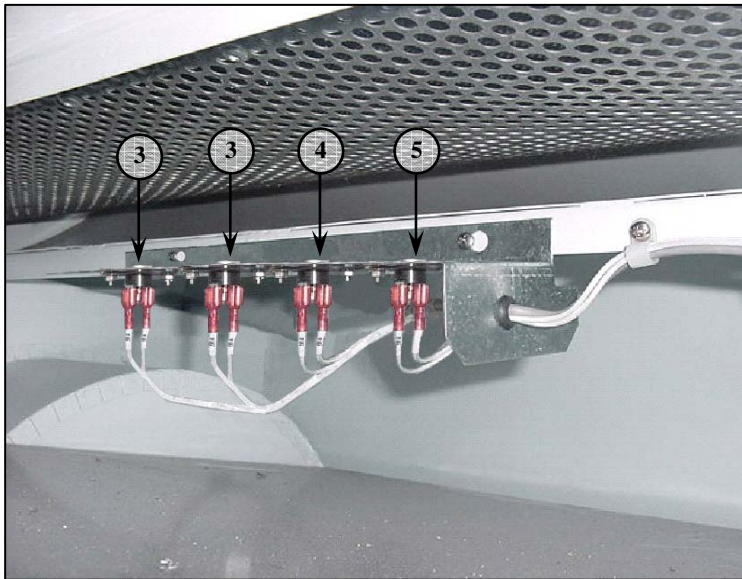

Model : Timer control

Item	Part No.	Qty.	Description
1	A0-E027-010	1	Temperature probe
2	A0-E016-011	1	Thermostat for high temp
3	A0-E016-011	2	Thermostat for "High Hear" selector
4	A0-E016-003	1	Thermostat for "Low Heat" selector
5	A0-E016-005	1	Thermostat for "Perm Press" selector



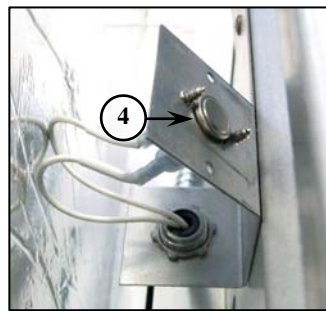
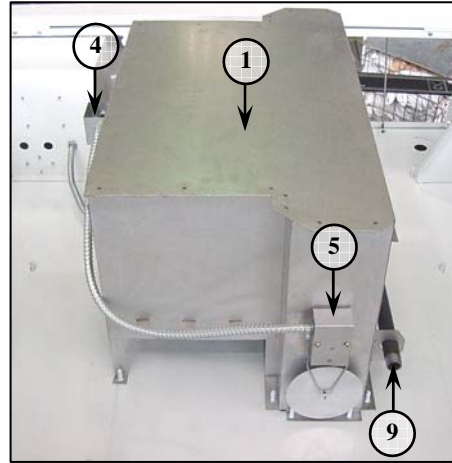
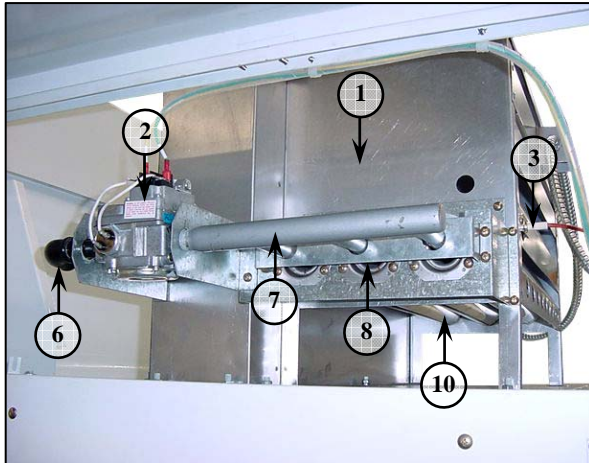

Item	Part No.	Qty.	Description
1	A0-A027-004	1	Burner gas
2	A0-E018-003	1	Gas valve (LP Gas)
	A0-E018-003	1	Gas valve (Natural Gas)
3	A0-E019-005	1	Spark probe
	A0-E019-006	1	Wire, Suppression
4	A0-E016-013	1	Thermostat
5	A0-E014-010	1	Micro switch
	A2-SDE1-028	1	Cabinet sail switch complete shell (Gas safety)
6	A0-A011-002	1	Nipple
7	A2-S170-034	1	Burner tube stainless steel
8	A0-A105-002-01	4	Nozzles gas LP Gas brass 1/4"
	A0-A105-002-02	4	Nozzles gas NGas brass 1/4"
9	A2-S170-036	1	Pipe, Gas inlet
10	A0-A089-002	4	Gas burner tube

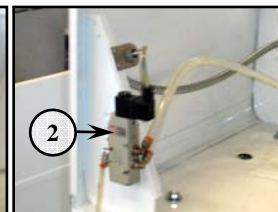
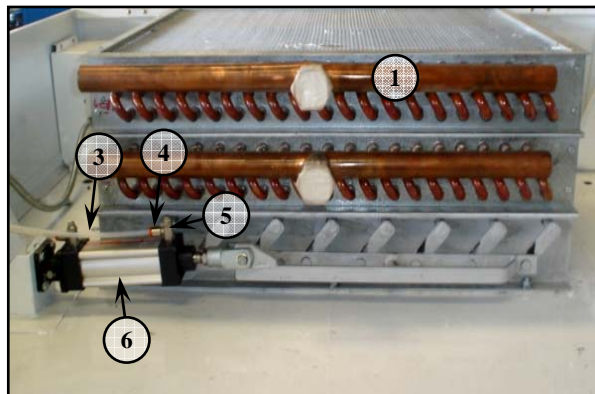
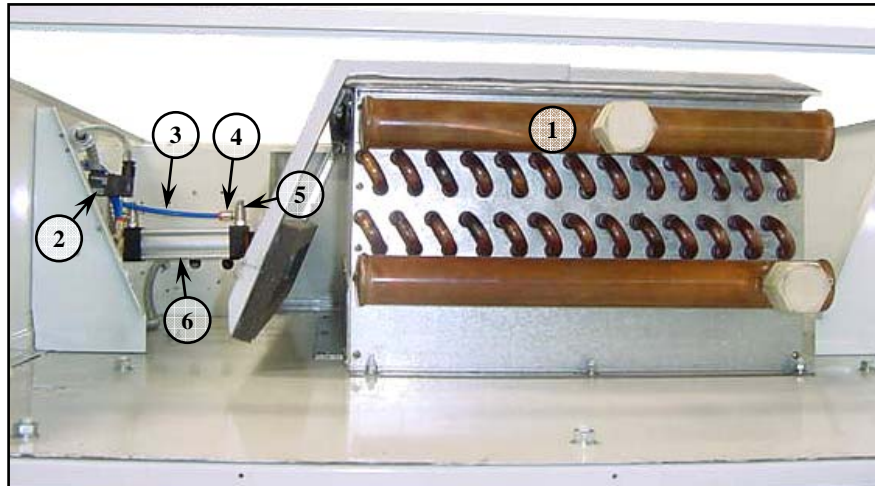

Item	Part No.	Qty.	Description
1	A0-A026-005	1	Steam coil
	A0-E047-006	1	Solenoid steam valve
2	A0-P005-050	1	Air solenoid valve
3	A0-P007-002	3	Tube PU polyurethane
4	A0-P006-100	3	Fitting elbow
5	A0-P006-101	2	Silencer
	A0-P009-003	2	Speed control valve
6	A0-P003-022	1	Air cylinder

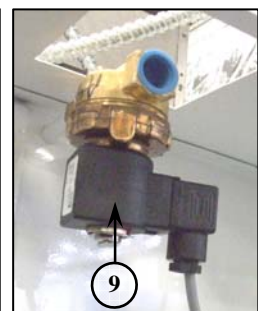
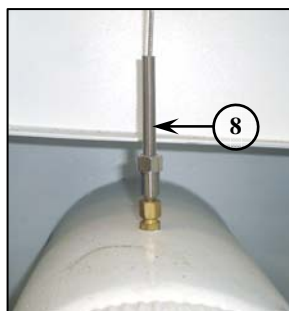
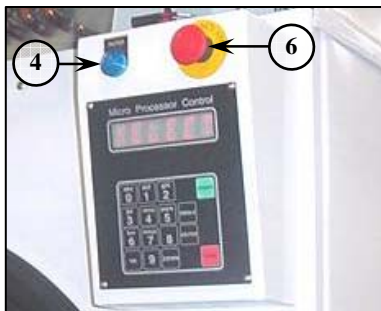
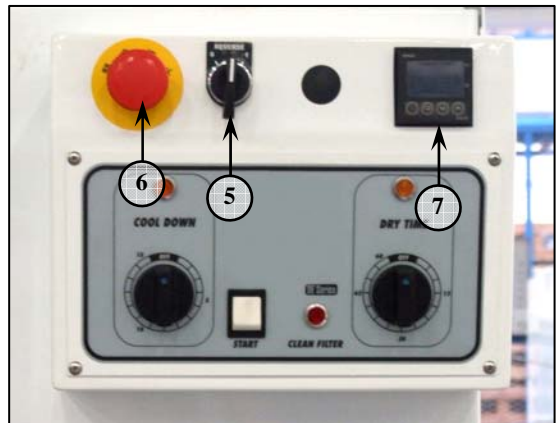
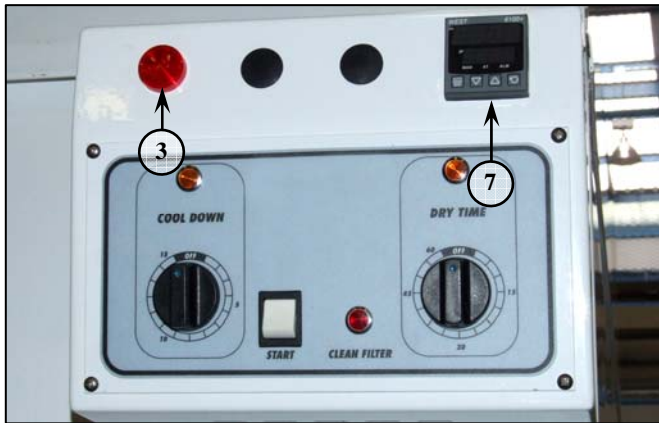
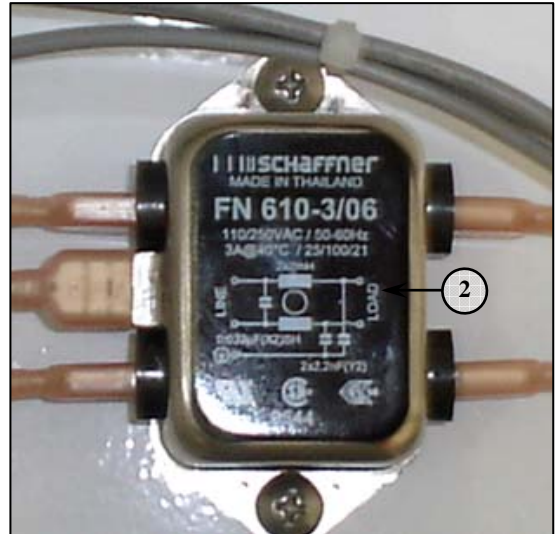
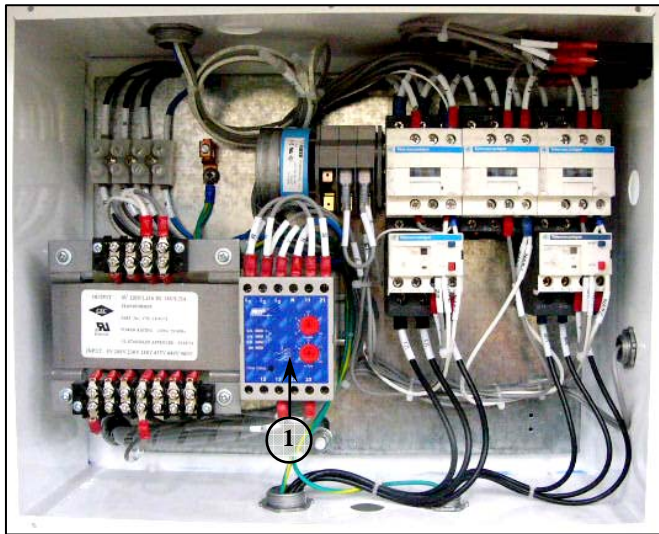

Item	Part No.	Qty.	Description
1	A0-E010-024	1	Phase protection
2	A0-E003-014	1	EMI Filter
3	A0-E035-019	1	Lamp indicator (Red)
4	A0-E035-021	1	Lamp indicator (Blue)
5	A0-E033-003	1	Selector switch
6	A0-E032-018	1	Emergency stop
7	A0-E027-040	1	Temperature controller
8	A0-E027-033	1	Temperature sensor
9	A0-E040-001	1	Sprinkle valve

